

Mini Expanded Beam Connector

Fiber Optic Connectors

The Cinch Advantage

Mini expanded beam fiber optic connectors have been designed for use in the most demanding harsh environment applications including military tactical communications, outside broadcast, petrochemical plant, mining and offshore systems.

The Mini expanded beam plug connector has a diameter of just 21mm making it ideal for applications where size and space requirements are critical. The Mini bulkhead connector is available with D-hole, square flange and XLR mounting options. Low profile versions are also available.

The connectors are terminated using an epoxy-polish ferrule termination process with standard fiber optic termination tools and equipment. The terminated ferrules are simply inserted into the expanded beam housing and fixed in place via a spring and cover-plate. Ferrule alignment to the lenses is achieved automatically by the unique optical arrangement developed and patented by Cinch-Fibreco.

The Fibreco® Mini expanded beam connectors offer high performance, flexibility and cost effectiveness, combined with a simple termination process allowing rapid in-field termination and repair.

Features

- Mini 1 – Stratos HMC singlemode compatible
- Mini 2 – Tyco Pro-Beam Mini & Telecast MX compatible
- Mini 3 – Stratos HMC multimode compatible
- Singlemode and multimode options
- Field repairable: EB insert & shell components replaceable / re-useable
- Field terminable using standard termination tools & equipment
- 1, 2 & 4 channel plugs and bulkheads
- Variants: material, finish, blkd mount
- Options: XLR, low profile & reversed
- RoHS compliant 

Outline Specification

Insertion Loss	9/125 Fiber at 1310nm / 1550nm: -1.5dB maximum (typical <-1.0dB)* 50/125 Fiber at 850nm / 1300nm: -1.0dB maximum (typical <-0.7dB)*
Return Loss	> 32dB (typical 40dB) singlemode / >20dB multimode*
Durability	3000 Matings minimum
Operating Temperature	High Temp: +85°C for 10 hours; Low Temp: -40°C for 10 hours
Storage Temperature	-55°C to +85°C
Water Immersion	15m for 24 hours (Plug & Bulkhead, Mated & Open Face)
Free Fall Resistance	500 Falls from 1.2m height
Vibration	10-500Hz, 3 directions, 0.75mm amplitude@ 10g acceleration
Bump	4000 bumps @ 40g acceleration
Crush Resistance	6.7kN
Corrosion Resistance	500 Hours Salt Spray
Cable Retention	1500N (Cable Dependant)
Weight (approx)	Plug: 70g Bulkhead: 65g
Connector Shell Material / Color	Black Anodised Aluminum, or Stainless Steel. Grip & boot: Black

Optical Insert Arrangements

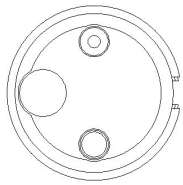

2086 - 1CH OPTICAL

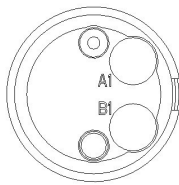

1745 - 2CH OPTICAL

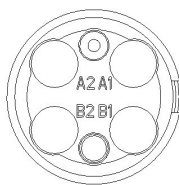

1746 - 4CH OPTICAL

Plug Connector

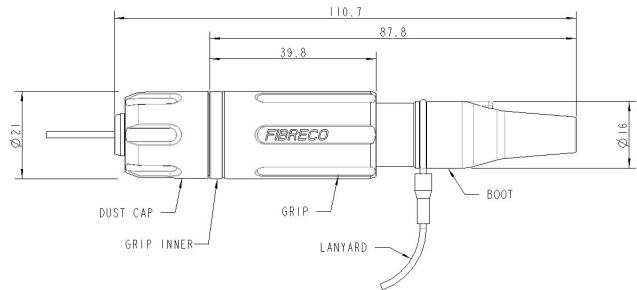

Bulkhead Connector D-Hole Mount

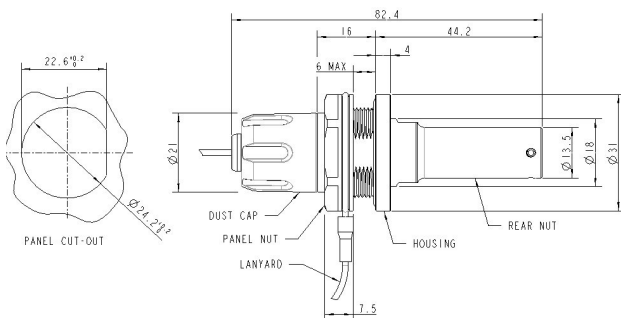

Bulkhead Connector Square-Flange Mount

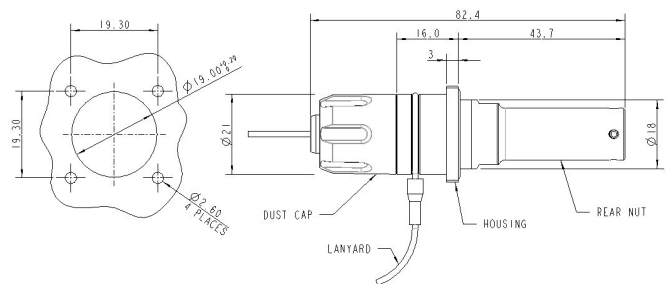

Cinch Connectivity Solutions reserves the right to change specifications without notice



Asia Pacific
+86 21 5442 7668
ccs.asia.sales@as.cinch.com

Europe, Middle East & Africa
+44 (0) 1245 342060
CinchConnectivity@eu.cinch.com

North America
+1 507.833.8822
ccsorders@us.cinch.com

belfuse.com/cinch